

# Service Manual

Tuner

AM/FM Stereo Tuner (ST-300)  
LW/MW/FM Stereo Tuner (ST-300L)

## ST-300 ST-300L

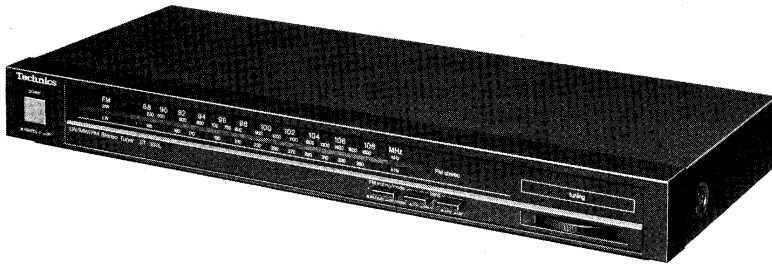

\* This photo is ST-300L.

## Color

(K)...Black Type  
(S)...Silver Type

Color	Areas
(K) (S)	[EX]...Continental Europe. (ST-300/300L)
(K) (S)	[EK]...United Kingdom. (ST-300L)
(K) (S)	[EB]...Belgium. (ST-300L)
(K) (S)	[EH]...Holland. (ST-300)
(K) (S)	[XA]...Asia, Oceania, Latin America, Middle Near East and Africa. (ST-300)
(K) (S)	[XL]...Australia. (ST-300)

## SPECIFICATIONS

(DIN 45 500)

### ■ FM TUNER SECTION

Frequency range	88~108 MHz
Sensitivity	0.95 $\mu$ V/75 $\Omega$ (IHF, '58)
S/N 30 dB	1.0 $\mu$ V (75 $\Omega$ )
S/N 26 dB	0.9 $\mu$ V (75 $\Omega$ )
S/N 20 dB	0.8 $\mu$ V (75 $\Omega$ )
IHF 46 dB stereo quieting sensitivity	22 $\mu$ V/75 $\Omega$
Total harmonic distortion	
MONO	0.15%
STEREO	0.3%
S/N	
MONO	70 dB (78 dB, IHF, '58)
STEREO	65 dB (70 dB, IHF, '58)
Frequency response	20 Hz~15 kHz, +0.5 dB~-1.5 dB
Alternate channel selectivity	
normal $\pm$ 400 kHz	65 dB
Capture ratio	1.0 dB
Image rejection at 98 MHz	40 dB
IF rejection at 98 MHz	70 dB
Spurious response rejection at 98 MHz	70 dB
AM suppression	50 dB
Stereo separation	
1 kHz	40 dB
10 kHz	30 dB
Carrier leak	
19 kHz	-30 dB (-35 dB, IHF)
38 kHz	-45 dB (-50 dB, IHF)
Channel balance (250 Hz~6,300 Hz)	$\pm$ 1.5 dB

Limiting point	1.2 $\mu$ V
Bandwidth	
IF amplifier	180 kHz
FM demodulator	1000 kHz
Antenna terminals	75 $\Omega$ (unbalanced)

### ■ AM TUNER SECTION (ST-300)

Frequency range	527~1605 kHz
Sensitivity (S/N 20 dB)	20 $\mu$ V, 300 $\mu$ V/m
Selectivity ( $\pm$ 10 kHz)	27 dB
Image rejection at 1,000 kHz	40 dB
IF rejection at 1,000 kHz	60 dB

### ■ AM TUNER SECTION (ST-300L)

Frequency range	
MW	527~1605 kHz
LW	145~350 kHz
Sensitivity (S/N 20 dB)	
MW	20 $\mu$ V, 300 $\mu$ V/m
LW	50 $\mu$ V
Selectivity ( $\pm$ 10 kHz)	
MW at 1,000 kHz	27 dB
LW at 250 kHz	35 dB
Image rejection	
MW at 1,000 kHz	40 dB
LW at 250 kHz	40 dB

# Technics

Matsushita Electric Trading Co., Ltd.  
P.O. Box 288, Central Osaka Japan

# ST-300/300L

IF rejection at 1,000 kHz  
 MW at 1,000 kHz 60 dB  
 LW at 250 kHz 40 dB

## GENERAL

Output voltage 0.3V (0.6V IHF)  
 Power consumption 6W  
 Power supply  
 For United Kingdom and Australia AC 50 Hz/60 Hz, 240V

For continental Europe AC 50 Hz/60 Hz, 220V  
 For others AC 50 Hz/60 Hz, 110V/127V/220V/240V  
 Dimensions (W×H×D) 430 × 53 × 180 mm  
 (16-15/16" × 2-3/32" × 7-3/32")  
 Weight 1.7 kg  
 (3.8 lb.)

Note:  
 Total harmonic distortion is measured by the digital spectrum analyzer (H.P. 3045 system).

## CONTENTS

	Page		Page
LOCATION OF CONTROLS	2	CIRCUIT BOARDS AND WIRING CONNECTION	
OPERATION (ST-300L)	3	DIAGRAM (ST-300)	9, 10
DISASSEMBLY INSTRUCTIONS	4	CIRCUIT BOARDS AND WIRING CONNECTION	
DIAL CORD INSTALLATION GUIDE	4	DIAGRAM (ST-300L)	11, 12
RESISTORS AND CAPACITORS	5	BLOCK DIAGRAM	13, 14
MEASUREMENTS AND ADJUSTMENTS	6~8	SCHEMATIC DIAGRAM	15~17
TERMINAL GUIDE OF IC'S,		REPLACEMENT PARTS LIST	18, 19
TRANSISTORS AND DIODES	8	EXPLODED VIEW	19, 20

## LOCATION OF CONTROLS

### Front panel (ST-300L)

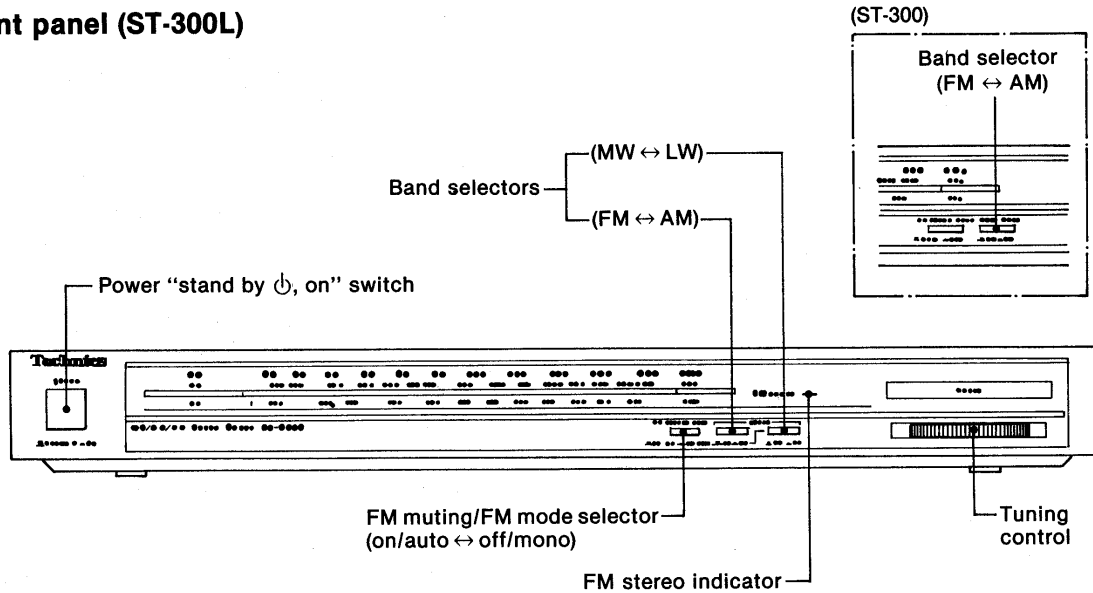

### Rear panel

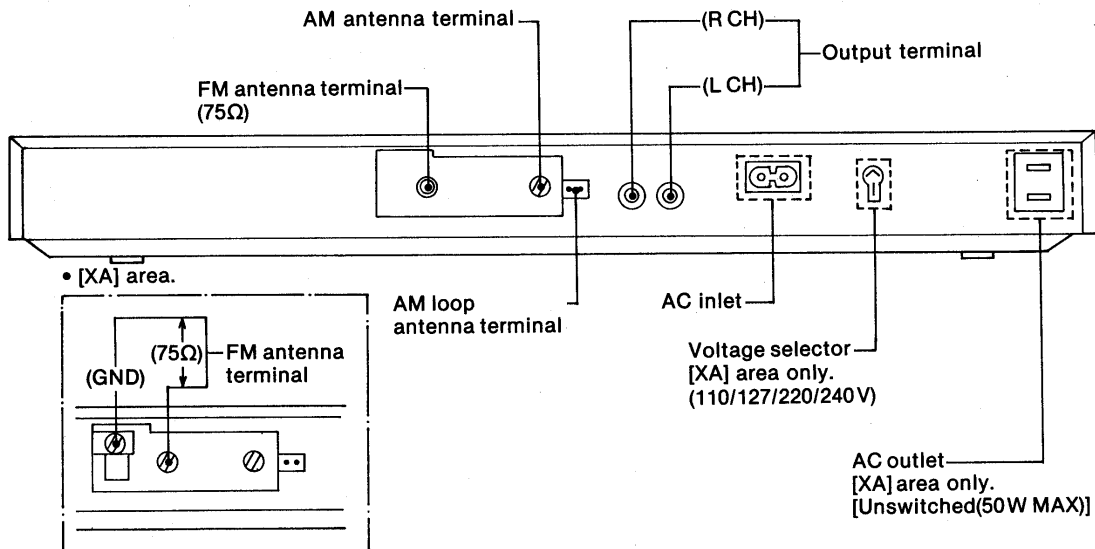

**■ OPERATION (ST-300L)**

**Important!**

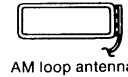

If this antenna is not installed, AM broadcasts will not be received.

**1** Turn the amplifier on, and prepare it for listening to radio broadcasts.

**Power “stand by  $\phi$ , on” switch**

**2** “on” (  $\phi \rightarrow \text{■}$  )

This switch turns on and off the secondary circuit power only. The unit is in the “stand-by” condition when this switch is set to the “stand by  $\phi$ ” position. Regardless of the switch setting, the primary circuit is always “live” as long as the power cord is connected to an electrical outlet.

**Band selectors (band)**

**3-1** “FM” (  $\text{■} \rightarrow \text{■}$  ) or “AM” (  $\text{■} \rightarrow \text{■}$  )

**For AM broadcasts only**

**3-2** “MW” (  $\text{■} \rightarrow \text{■}$  ) or “LW” (  $\text{■} \rightarrow \text{■}$  )

**Note:**

In this instance, be sure to select “AM” in step 3-1.

**Tuning control (tuning)**

**4** Tune to the desired broadcast.

**5** **Volume adjustment:**

Adjust the volume and tone quality, if necessary, by using the controls on the amplifier.

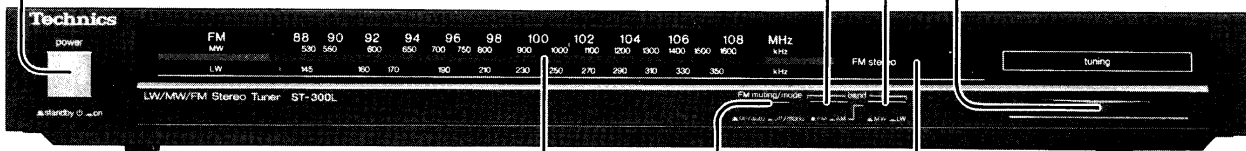

**Power/tuning indicator**

This indicator illuminates when the power is switched ON and, during tuning to an FM or AM broadcast, the illumination becomes brighter at the best tuned position.

**FM stereo indicator (FM stereo)**

This indicator automatically illuminates when an FM stereo broadcast is being received.

**FM muting/FM mode selector (FM muting/mode)**

This selector is used during tuning to eliminate the annoying noise between FM broadcast stations, and to select either stereo or monaural reception of FM broadcasts.

If the broadcast signal is weak, or if there is a large amount of interference in a stereo broadcast, set to the “off/mono” position.

Note that the FM stereo indicator will not illuminate in this position.

## DISASSEMBLY INSTRUCTIONS

Ref. No. 1	How to remove the main P.C.B.
<ul style="list-style-type: none"> <li>Remove the 7 screws.</li> </ul>	<ul style="list-style-type: none"> <li>Remove the 7 screws.</li> </ul>
<ul style="list-style-type: none"> <li>Slightly pull the front panel toward you and remove the printed circuit board.</li> </ul>	<p>(Slightly pull the chassis toward you and lift it in the direction of arrow)</p>

## DIAL CORD INSTALLATION GUIDE

### When setting the cord, follow the procedure given below

- The cord should be at least 150 cm long.
- Completely turn the tuning gang (variable capacitor) counterclockwise. (Variable condenser capacity: max. Frequency: min.).
- Make a knot at the cord and as shown in Fig. 1.
- Set the spring to the knot, and set the cord in the order of 1 ~ 8.

**Note:** At step 5, pull the cord strongly, slacken the spring up to the mark of the drum, then go to step 6 ~ 8 to set the cord.

- Fix the cord terminal with adhesive.
- Cut off the cord about 5 mm at its either end.

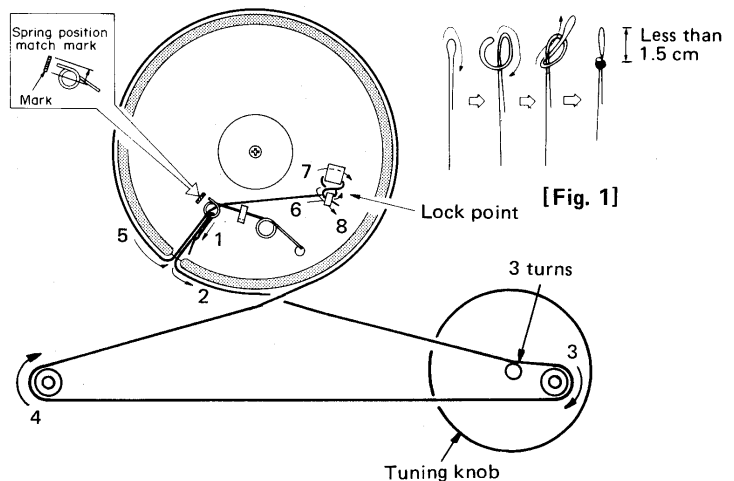

**RESISTORS AND CAPACITORS**

- Notes:**
- Part numbers are indicated on most mechanical parts. Please use this part number for parts order.
  - Important safety notice. Components identified by  $\Delta$  mark have special characteristics important for safety. When replacing any of these components, use only manufacturer's specified parts.

- The unit of resistance is OHM ( $\Omega$ ).  
K=1000 $\Omega$ , M=1000k $\Omega$
- The unit of capacitance is MICROFARAD ( $\mu$ F).  
P=10<sup>-6</sup> $\mu$ F.

**Numbering System of Resistor**

Example

ERD	25	F	J	101
Type	Wattage	Shape	Tolerance	Value

**Numbering System of Capacitor**

Example

ECKD	1H	102	Z	F
Type	Voltage	Value	Tolerance	Peculiarity

ECEA	50	M	R47	R
Type	Voltage	Peculiarity use	Value	Special use

Resistor Type	Wattage	Tolerance
ERD : Carbon	25 : 1/4W	F : $\pm 1\%$
ERC : Solid	S2 : 1/4W	J : $\pm 5\%$
ERO : Metal Film	S1 : 1/2W 12 : 1/2W	K : $\pm 1\%$

Capacitor Type	Voltage		Tolerance
	ECEA Type	Other	
ECEA : Electrolytic	0J : 6.3V	1H : 50V DC	C : $\pm 0.25\text{pF}$
ECCD : Ceramic	1A : 10V	1 : 125V DC	G : $\pm 2\%$
ECKD : Ceramic	1C : 16V	KC : 400V AC	J : $\pm 5\%$
ECQM : Polyester	1E : 25V		K : $\pm 10\%$
ECQP : Polypropylene	1H : 50V 1V : 35V 25 : 25V		Z : +80%, -20%

(ST-300L)

**RESISTORS**

Ref. No.	Part No.	Value
R1	ERDS2TJ102	1K
R2 [EK]	ERDS2TJ220	22
R2 [other]	ERDS2TJ560	56
R3	ERDS2TJ221	220
R4	ERDS2TJ474	470K
R5	ERDS2TJ471	470
R6	ERDS2TJ393	39K
R7	ERDS2TJ822	8.2K
R8	ERDS2TJ122	1.2K
R9	ERDS2TJ682	6.8K
R10	ERDS2TJ104	100K
R12	ERDS2TJ331	330
R101	ERDS2TJ392	3.9K
R102 [EK]	ERDS2TJ681	680
R102 [other]	ERDS2TJ471	470
R103	ERDS2TJ824	820K
R104	ERDS2TJ274	270K
R105, 106	ERDS2TJ471	470
R107	ERDS2TJ182	1.8K
R108	ERDS2TJ223	22K
R110	ERDS2TJ684	680K
R111 [EK] only	ERDS2TJ683	68K
R201	ERDS2TJ122	1.2K
R202	ERDS2TJ681	680
R251	ERDS2TJ103	10K
R252	ERDS2TJ102	1K
R303, 304	ERDS2TJ223	22K
R305	ERDS2TJ334	330K
R306	ERDS2TJ153	15K
R308	ERDS2TJ103	10K
R309	ERDS2TJ681	680
R310, 311	ERDS2TJ332	3.3K
R312, 313	ERDS2TJ333	33K
R314	ERDS2TJ473	47K
R315 [EK]	ERD25FJ330	33
R315 [other]	ERDS2TJ330	33
R501	ERDS2TJ182	1.8K
R503	ERDS2TJ332	3.3K
R504	ERDS2TJ152	1.5K
R505, 506	ERDS2TJ472	4.7K
R507, 508	ERDS2TJ563	56K
R509	ERDS2TJ122	1.2K
R510	ERDS2TJ822	8.2K
R511	ERDS2TJ561	560
R513	ERDS2TJ272	2.7K
R514	ERDS2TJ102	1K
R515, 516	ERDS2TJ104	100K

Ref. No.	Part No.	Value
R520	ERDS2TJ561	560
R701 [EK]	ERG1ANJ560	56
R701 [other]	ERG1ANJ470	47
R702	ERDS2TJ122	1.2K
R703	ERDS2TJ561	560

**CAPACITORS**

Ref. No.	Part No.	Value
C1 [EK]	ECCD1H180KC	18P
C1 [other]	ECCD1H220KC	22P
C2	ECCD1H180KC	18P
C3	ECCD1H220KC	22P
C4	ECKD1H102ZF	0.001
C5	ECKD1H103ZF	0.01
C6 [EK]	ECCD1H010CC	1P
C6 [other]	ECCD1H030CC	3P
C7	ECCD1H070CC	7P
C8	ECCD1H181K	180P
C9	ECCD1H390KC	39P
C10	ECCD1H150KC	15P
C11	ECKD1H102ZF	0.001
C13 [EK]	ECCD1H050CC	5P
C13 [other]	ECCD1H080CC	8P
C14	ECKD1H103ZF	0.01
C15	ECKD1H223ZF	0.022
C16	ECKD1H102ZF	0.001
C17	ECKD1H102ZF	0.001
Except [EK]		
C20	ECCD1H050CC	5P
C101, 102	ECKD1H103ZF	0.01
C103, 104	ECKD1H103ZF	0.01
C106	ECEA1HU010	1
C107	ECKD1H103ZF	0.01
C108	ECEA1CU100	10
C110	ECCD1H101K	100P
C111	ECKD1H473ZF	0.047
C114	ECKD1H103ZF	0.01
C202	ECCD1H050CC	5P
C203	ECQP1361JZ	360P
C204	ECKD1H103ZF	0.01
C205	ECEA0JU101	100
C206	ECEA1EU4R7	4.7

Ref. No.	Part No.	Value
C207	ECCD1H080CC	8P
C208	ECCD1H030CC	3P
C209	ECEA1CU100	10
C251	ECCD1H220KC	22P
C252	ECCD1H680K	68P
C253	ECQP1181JZ	180P
C254	ECCD1H030CC	3P
C255	ECEA1HUR47	0.47
C301	ECEA1EU4R7	4.7
C302	ECEA1CU101	100
C303	ECKD1H473ZF	0.047
C304	ECQP1471JZ	470P

Ref. No.	Part No.	Value
C305, 306	ECEA1HUR47	0.47
C307, 308	ECFTD153KXL	0.015
C309, 310	ECEA1HU010	1
C501	ECEA0JU470	47
C503	ECEA1CU100	10
C504	ECKD1H103ZF	0.01
C701, 702	ECEA1CU221	220
C703	ECKD1H103ZF	0.01
C704	ECEA1VU221	220
C705	ECEA1CU221	220
C707, 708	ECKD1H103ZF	0.01

**Change of Parts List (ST-300 from ST-300L)**

Ref. No.	Change of Part No.		Description
	ST-300L [EK]	ST-300 [EX, EH, XA, XL]	
<b>RESISTORS</b>			
R2	ERDS2TJ220	ERDS2TJ560	56 $\Omega$
R102	ERDS2TJ681	ERDS2TJ471	470 $\Omega$
R111	ERDS2TJ683	---	(Deletion)
R251	ERDS2TJ103	---	(Deletion)
R252	ERDS2TJ102	---	(Deletion)
R315	ERD25FJ330	ERDS2TJ330	33 $\Omega$
R701	ERG1ANJ560	ERG1ANJ470	47 $\Omega$
<b>CAPACITORS</b>			
C1	ECCD1H180KC	ECCD1H220KC	22pF
C6	ECCD1H010CC	ECCD1H030CC	3pF
C13	ECCD1H050CC	ECCD1H080CC	8pF
C202	ECCD1H050CC	---	(Deletion)
C203	ECQP1361JZ	ECCD1H020CC	2pF
C207	ECCD1H080CC	ECCD1H330K	33pF
C208	ECCD1H030CC	---	(Deletion)
C251	ECCD1H220KC	---	(Deletion)
C252	ECCD1H680K	---	(Deletion)
C253	ECQP1181JZ	---	(Deletion)
C254	ECCD1H030CC	---	(Deletion)
C255	ECEA1HUR47	---	(Deletion)

## MEASUREMENTS AND ADJUSTMENTS

### AM/FM (ST-300) LW/MW/FM (ST-300L)

#### Control positions and equipment used

- AM and FM signal generator (AM and FM-SG)
- Stereo modulator
- Distortion analyser
- Oscilloscope
- AC and DC electronic voltmeter (EVM)
- Frequency counter
- Choke coil (100  $\mu$ H)
- Resistor (100k $\Omega$ )
- Ceramic capacitor (200 pF)

**Note:** For T201 (AM (MW) IFT), adjusted parts is supplied.  
So, do not turn the cores of this parts.

#### AM (MW)-RF ADJUSTMENT

1. Test equipment connection is shown in figure.
2. Set the unit to "AM (MW)" position.
3. Place the radio dial to minimum and signal generator setting to 600kHz.
4. Adjust L202 and L203 for maximum output.
5. Place the radio dial to maximum and signal generator setting to 1500kHz.
6. Adjust CT201 and CT202 for maximum output.
7. Repeat steps 3.~6.

#### Note:

Antenna input level must be as low as possible being free from AGC.

**AM SIGNAL GENERATOR CONDITION**  
Modulation.....30%  
Modulation frequency .....400 Hz

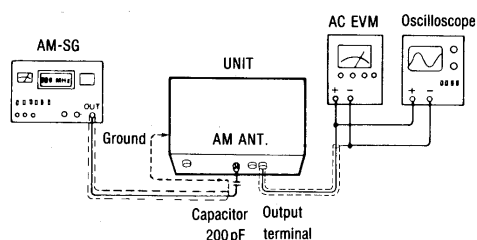

#### LW-RF ADJUSTMENT (ST-300L only)

1. Test equipment connection is shown in figure.
2. Set the unit to "LW" position.
3. Place the radio dial to minimum and signal generator setting to 145kHz.
4. Adjust L251 and L252 for maximum output.
5. Place the radio dial to maximum and signal generator setting to 350kHz.
6. Adjust CT251 and CT252 for maximum output.
7. Repeat steps 3.~6.

#### Note:

Antenna input level must be as low as possible being free from AGC.

**AM SIGNAL GENERATOR CONDITION**  
Modulation.....30%  
Modulation frequency .....400 Hz

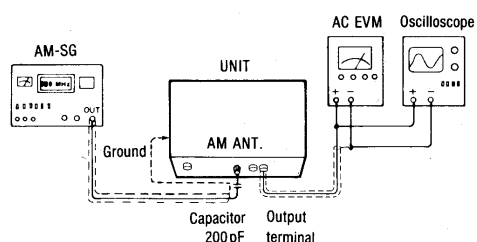

#### FM-IF ADJUSTMENT

1. Test equipment connection is shown in figure.
2. Set the unit to "FM on/auto" position.
3. Place the radio dial setting of non-interference.
4. Adjust T101 core so that voltage measured in no-signal mode is 0mV (0  $\pm$  50mV) in 300mV range.

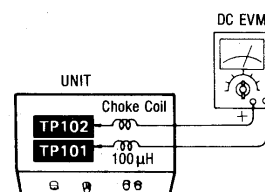

**FM-RF ADJUSTMENT**

1. Test equipment connection is shown in figure.
2. Set the unit to "FM" position.
3. Place the radio dial and signal generator setting to **90MHz**. Add weak input so that noise is included in the output waveform.
4. Adjust **L4** and **L2** so that the output waveform is vertically symmetrical.
5. Place the radio dial and signal generator setting to **106MHz**.
6. Adjust **CT1** so that the output waveform is vertically symmetrical.
7. Repeat steps 3.~6.

**FM SIGNAL GENERATOR CONDITION**  
 Modulation.....100%  
 Modulation frequency ..... 400Hz  
 Output level .....66dB

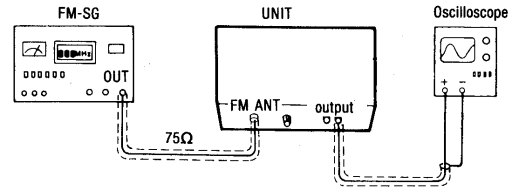

**FM MONO DISTORTION ADJUSTMENT**

1. Test equipment connection is shown in figure.
2. Set the unit to "FM" position.
3. Place the radio frequency display and no-signal generator setting to **100.10MHz**.
4. Adjust **T101** core so that voltage measured in signal mode is **0mV (0±50mV)** in 300mV range.
5. Repeat steps 4 a few times.
6. Make sure that the distortion factors of Lch and Rch are nearly the same with each other to minimum.

**FM SIGNAL GENERATOR CONDITION**  
 Modulation.....100%  
 Modulation frequency ..... 400Hz  
 Output level .....66dB

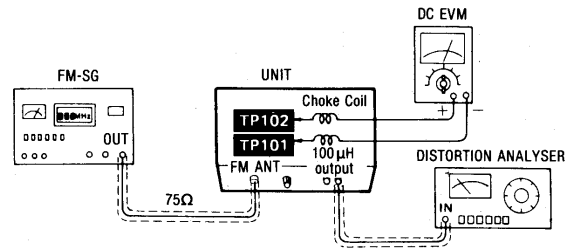

**Note:**

The adjusting screwdriver used should be made of resin.

**MPX VCO ADJUSTMENT**

1. Test equipment connection is shown in figure.
2. Set the unit to "on/auto" position.
3. Place the radio dial and signal generator setting to **100MHz**.
4. Adjust **VR301** for **19kHz±30Hz** on frequency counter reading.

**FM SIGNAL GENERATOR CONDITION**  
 Modulation.....0% (monaural signal)  
 Output level .....66dB

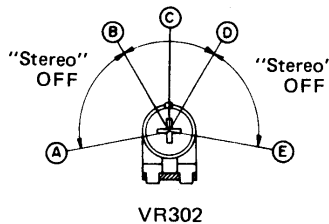
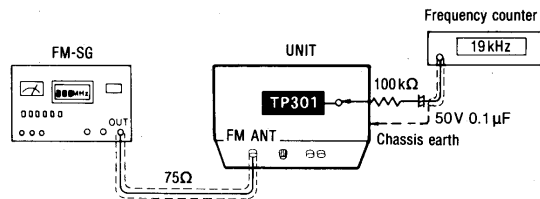

- (A) — (B),
- (D) — (E)..... "Stereo" OFF position
- (B) — (D)..... "Stereo" ON position (Indicator lighting)
- (C)..... Adjust point of pilot circuit

# ST-300/300L

## Adjustment Points

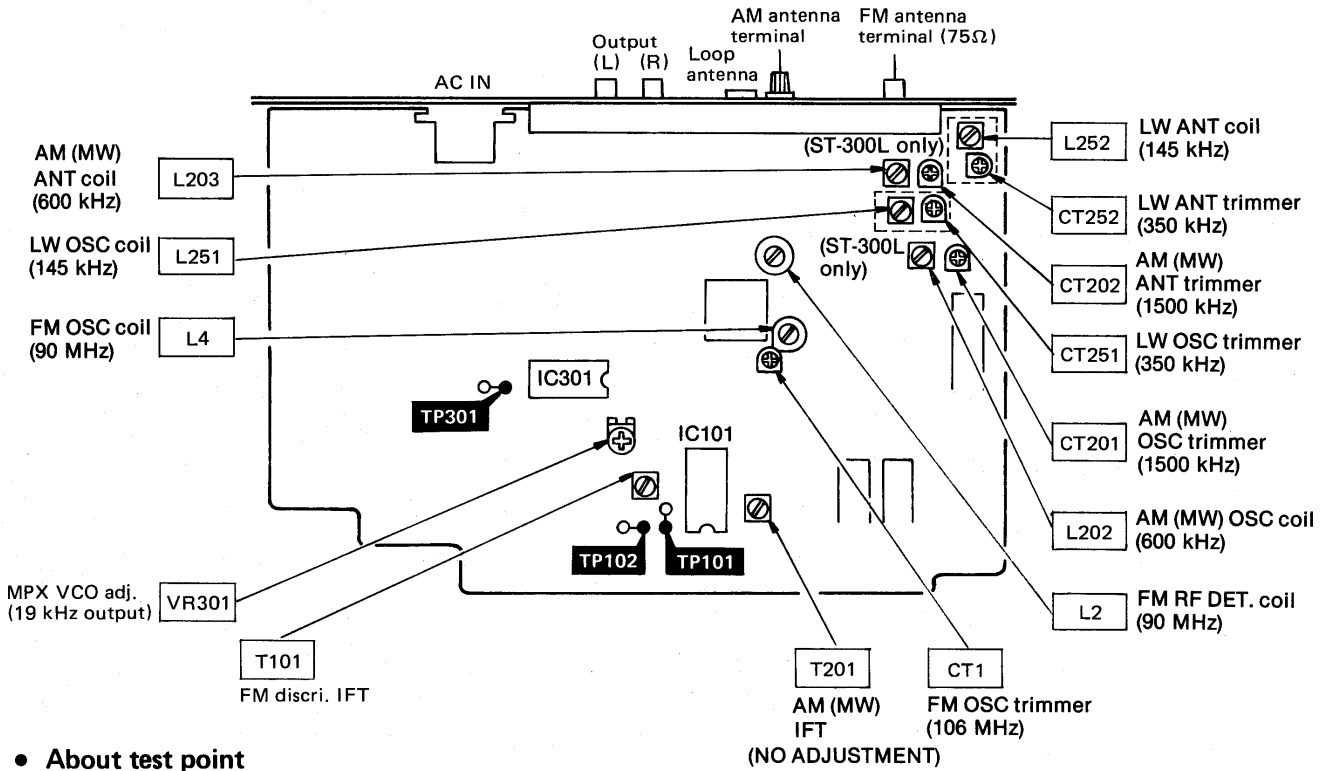



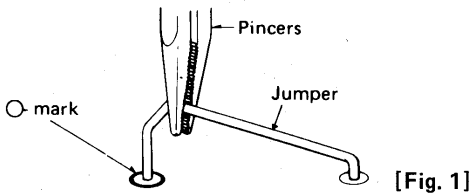



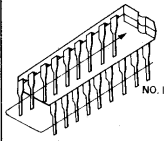
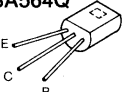
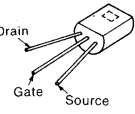
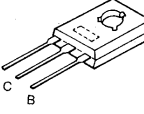
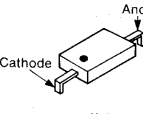

### About test point

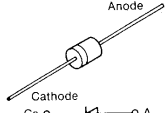

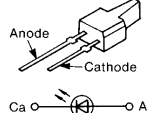
It can be removed by pulling the  - marked side by use of pincers. Insert it into the original hole when not needed.

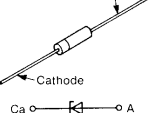
## TERMINAL GUIDE OF IC'S, TRANSISTORS AND DIODES

 <table border="1" data-bbox="343 1456 539 1545"> <tr> <td>AN7273A</td> <td>18 pin</td> </tr> <tr> <td>SV<math>\mu</math>PC1161C3</td> <td>16 pin</td> </tr> </table>	AN7273A	18 pin	SV $\mu$ PC1161C3	16 pin	<p>2SC1674M 2SC1675L 2SC1685 2SA564Q</p>  <p>E C B</p>	<p>2SK241</p>  <p>Drain Gate Source</p>	<p>2SD882P</p>  <p>E C B</p>	<p>MA345</p>  <p>Anode Cathode Ca  A</p>
AN7273A	18 pin							
SV $\mu$ PC1161C3	16 pin							
<p>MA165, MA27W SVDSR1K2</p>  <p>Anode Cathode Ca  A</p>	<p>LN846RP SVDLB72UR5HL</p>  <p>Anode Cathode Ca  A</p>	<p>MA4130M</p>  <p>Anode Cathode Ca  A</p>						



**■ CIRCUIT BOARDS AND WIRING CONNECTION DIAGRAM (ST-300)**

A  
B  
C  
D  
E  
F  
G

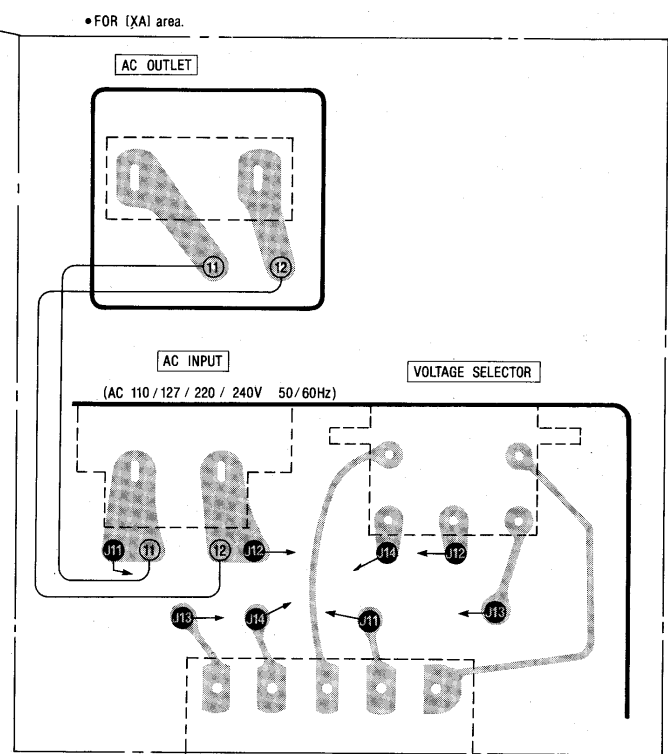
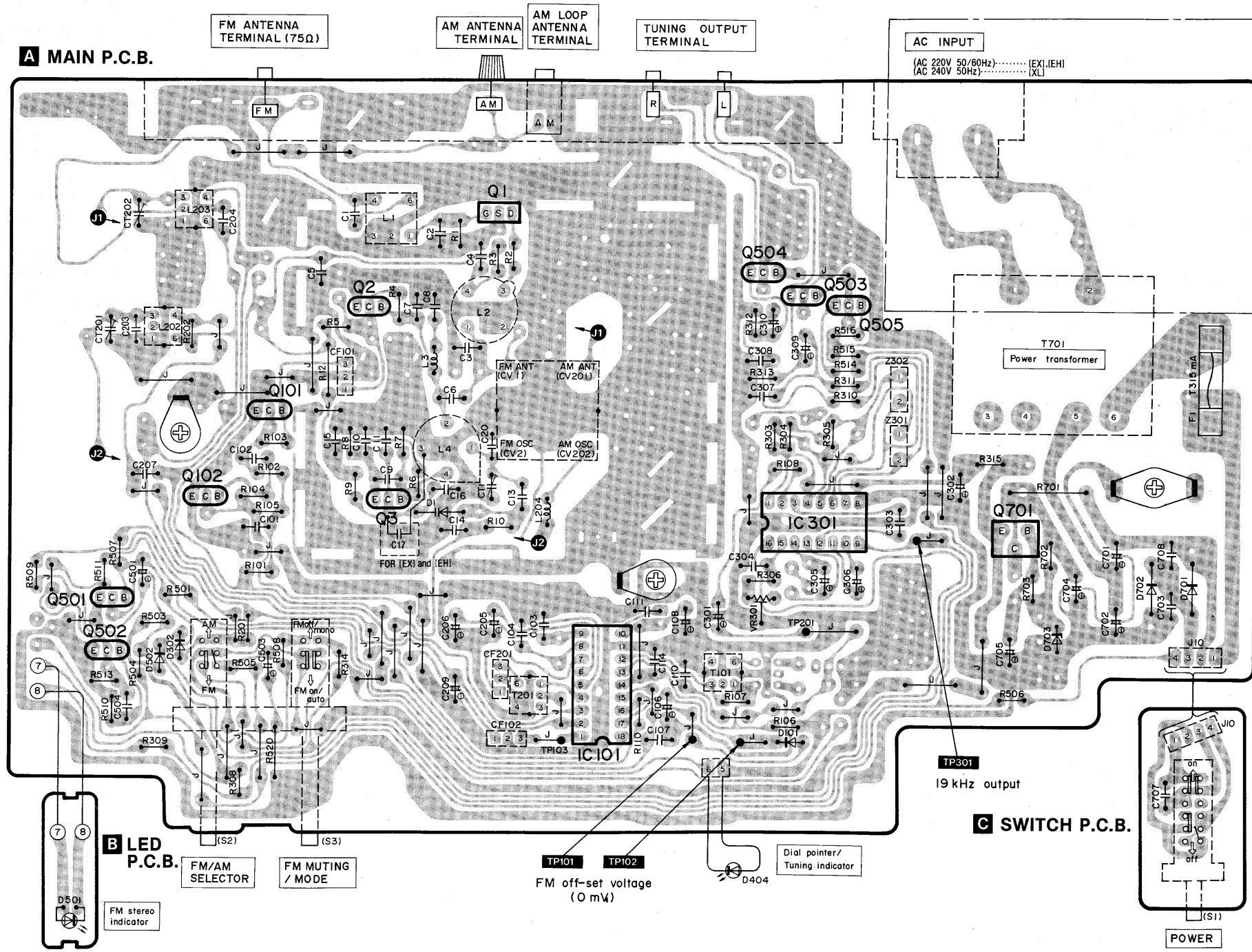

■ CIRCUIT BOARDS AND WIRING CONNECTION DIAGRAM (ST-300L)

A  
B  
C  
D  
E  
F  
G

1 2 3 4 5 6 7 8 9

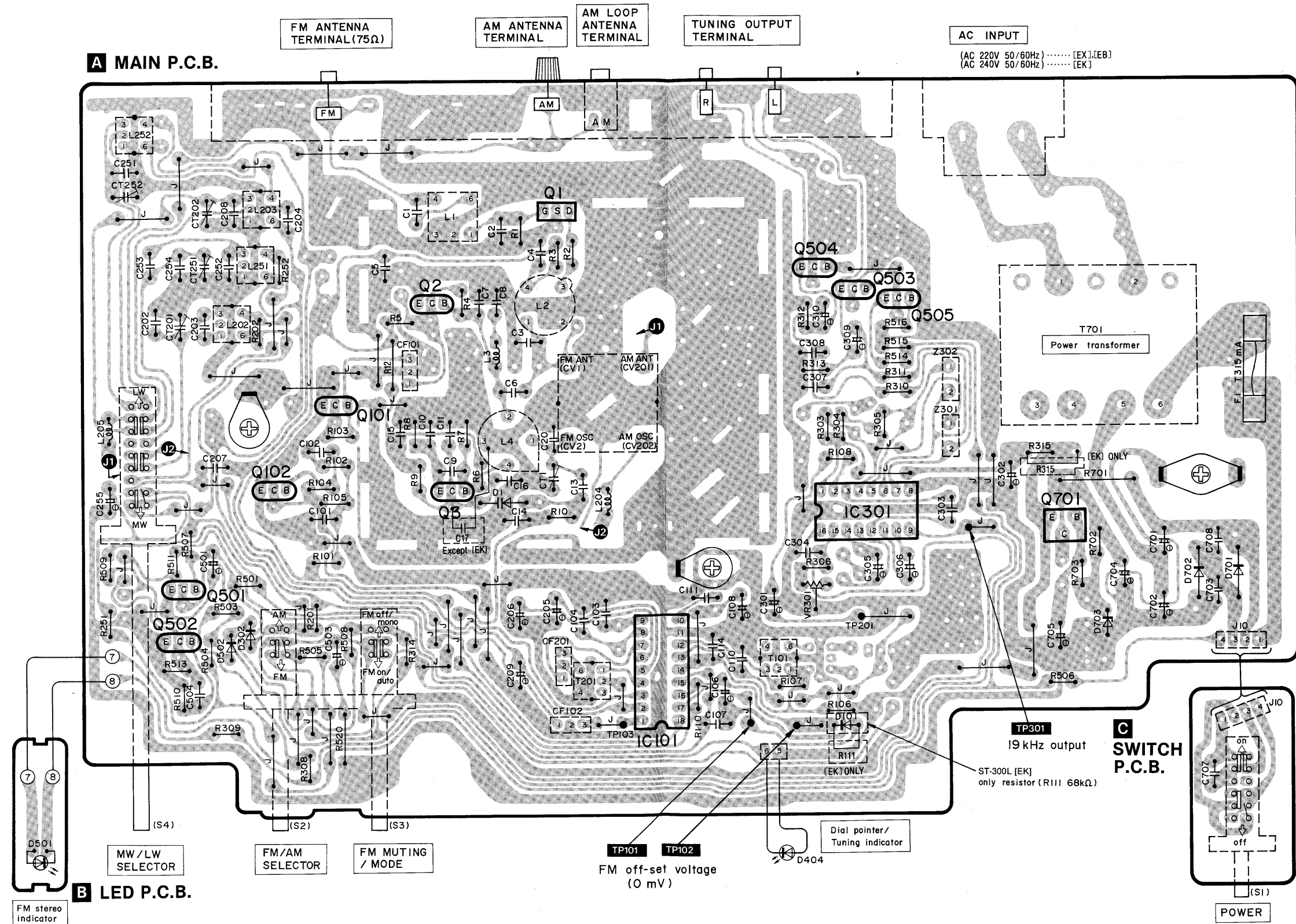

# ST-300/300L ST-300/300L

## ■ BLOCK DIAGRAM

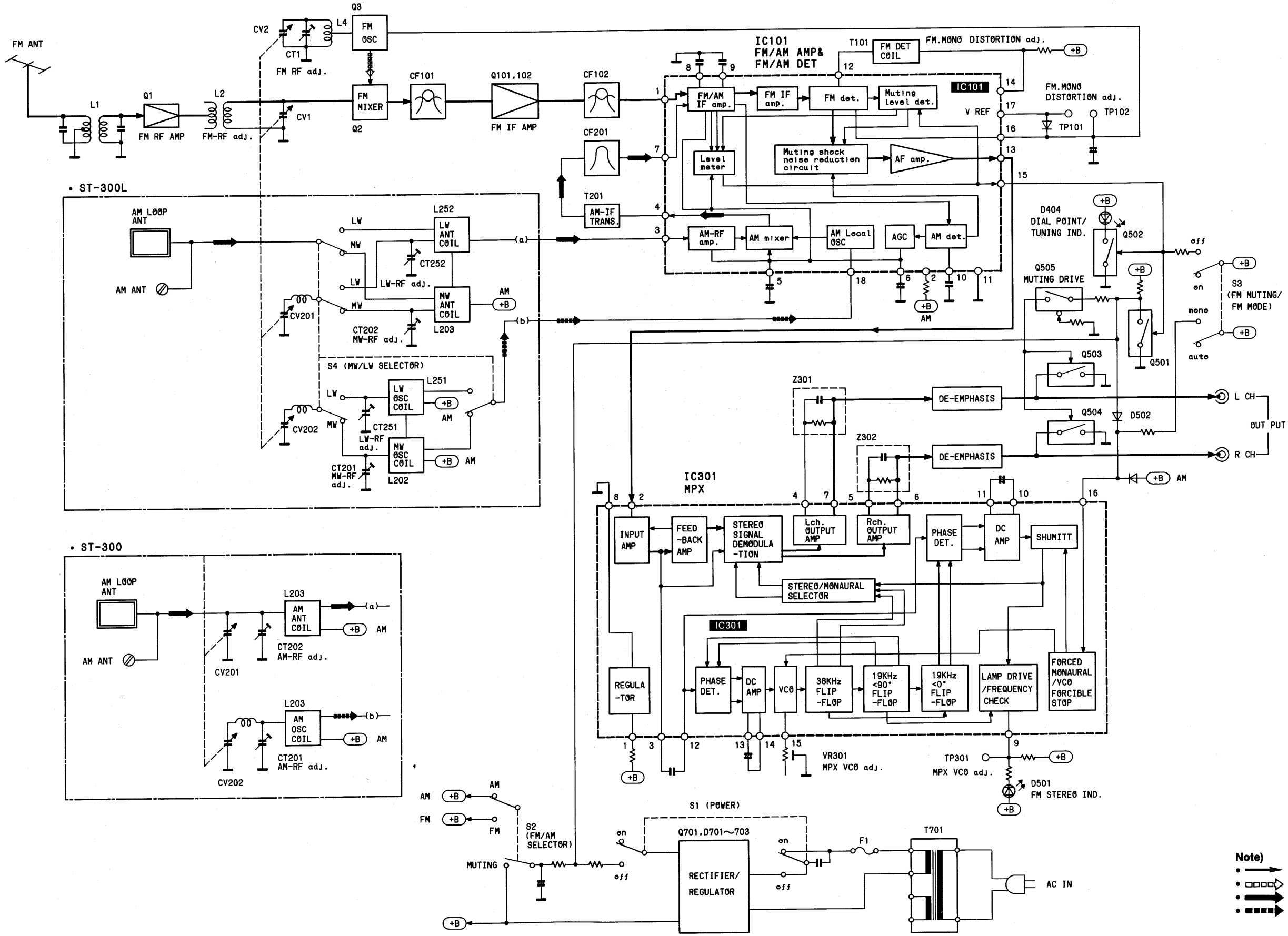

**Note)**  
 • FM Signal  
 • FM OSC  
 • AM Signal  
 • AM OSC

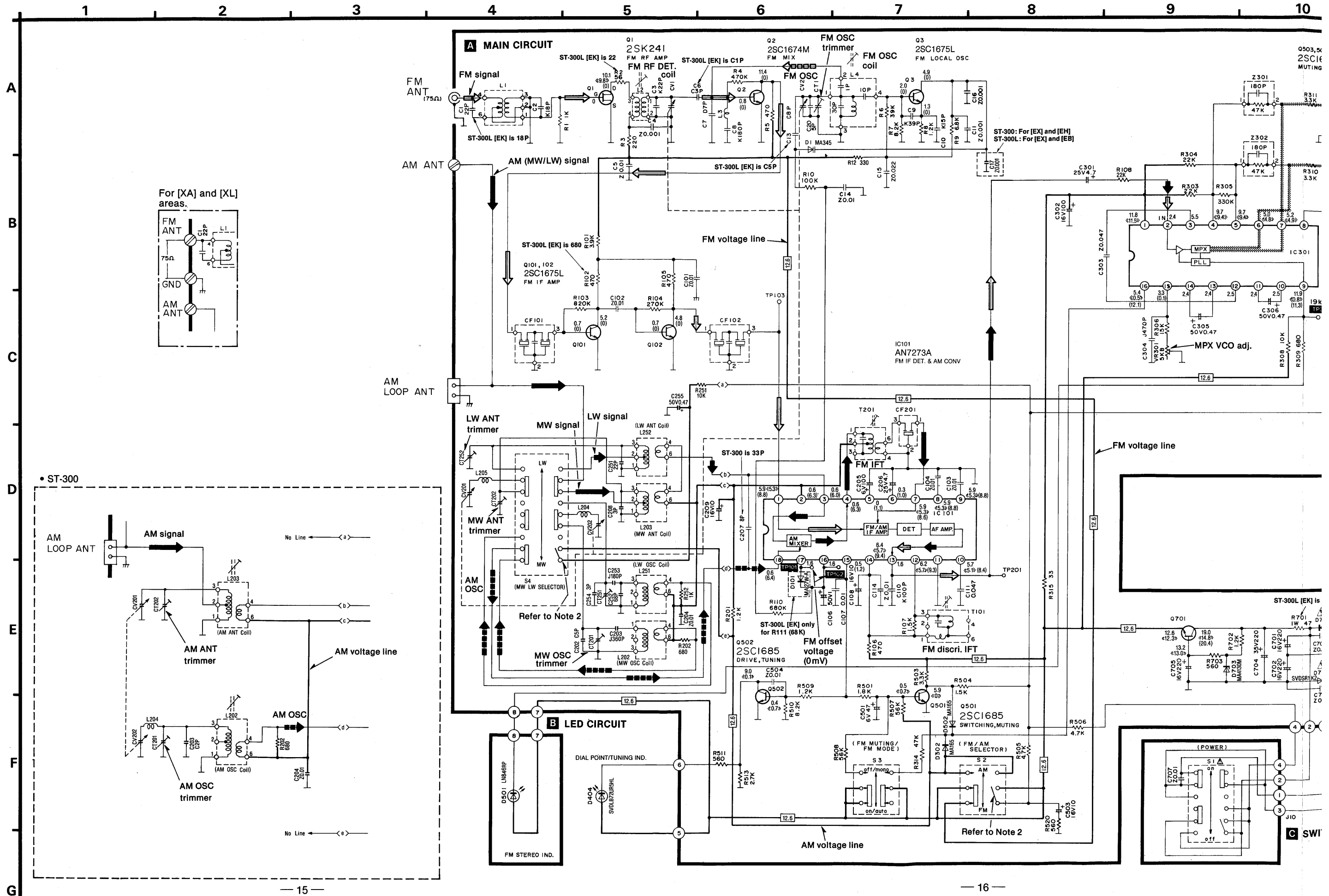

For [XA] and [XL] areas.

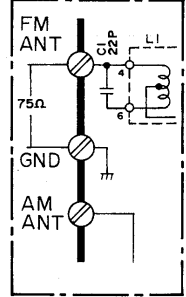

• ST-300

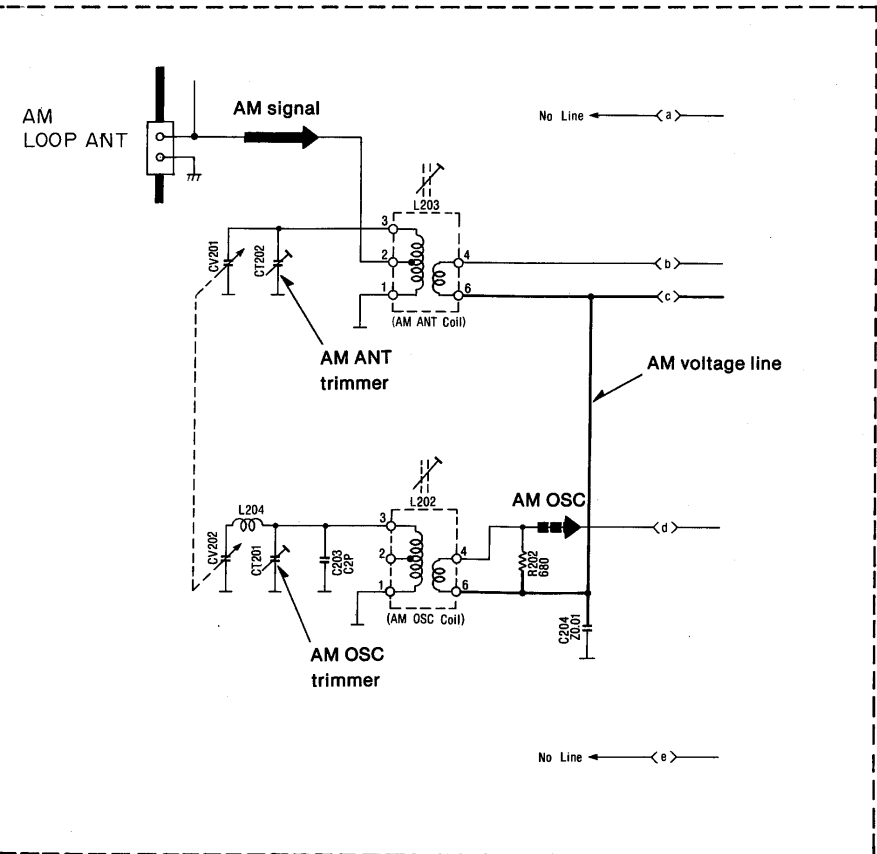

**B LED CIRCUIT**

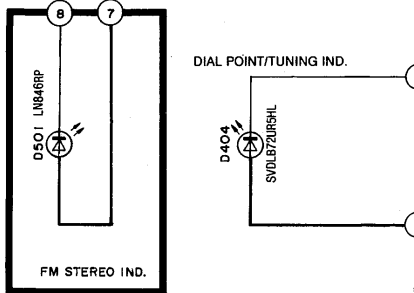

**C SWI**

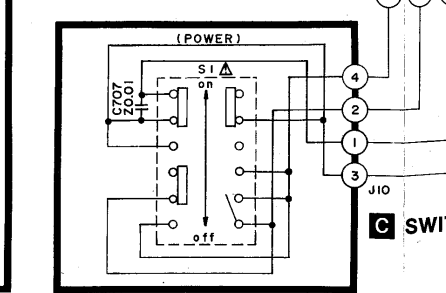

**SCHEMATIC DIAGRAM**

(This schematic diagram may be modified at any time with the development of new technology.)

**Note 1:**

- **S1** : Power source switch in "on" position.
  - **S2** : Band selector switch in "FM" position.  
FM ↔ AM
  - **S3** : FM muting/FM mode selector switch in "on/FM auto" position.  
on/FM auto ↔ off/FM mono
  - **S4 (ST-300L only)** : AM band selector switch in "MW" position.  
MW ↔ LW
  - **S5 ([XA] area.)** : Voltage selector switch in "220V" position.  
110V ↔ 127V ↔ 220V ↔ 240V
- Indicated voltage values are the standard values for the unit measured by the DC electronic circuit tester (high-impedance) with the chassis taken as standard. Therefore, there may exist some errors in the voltage values, depending on the internal impedance of the DC circuit tester.
- All voltage values shown in circuitry are DC voltage in FM signal (no signal) reception mode and "normal" mode of the FM IF band.
- \* Figures in ◀ ▶ stand for DC voltage in FM stereo signal reception mode.
- \* Figures in ( ) stand for DC voltage in AM (MW) signal reception mode.
- — Positive voltage lines.
  - — FM signal
  - — AM signal
  - — AF signal.
  - — FM OSC
  - — AM OSC
- Important safety notice.  
Components identified by Δ mark have special characteristics important for safety.  
When replacing any of these components, use only manufacturer's specified parts.

**Note 2:**

Muting switch part. When switch is turned on it is positioned as shown only for a moment. Usually, it is not connected to the circuit.

Part No.	Original Part No.	Supplyment Part No.
Q505	2SA564	2SA722S

**Power source circuit**

• For [XA] area.

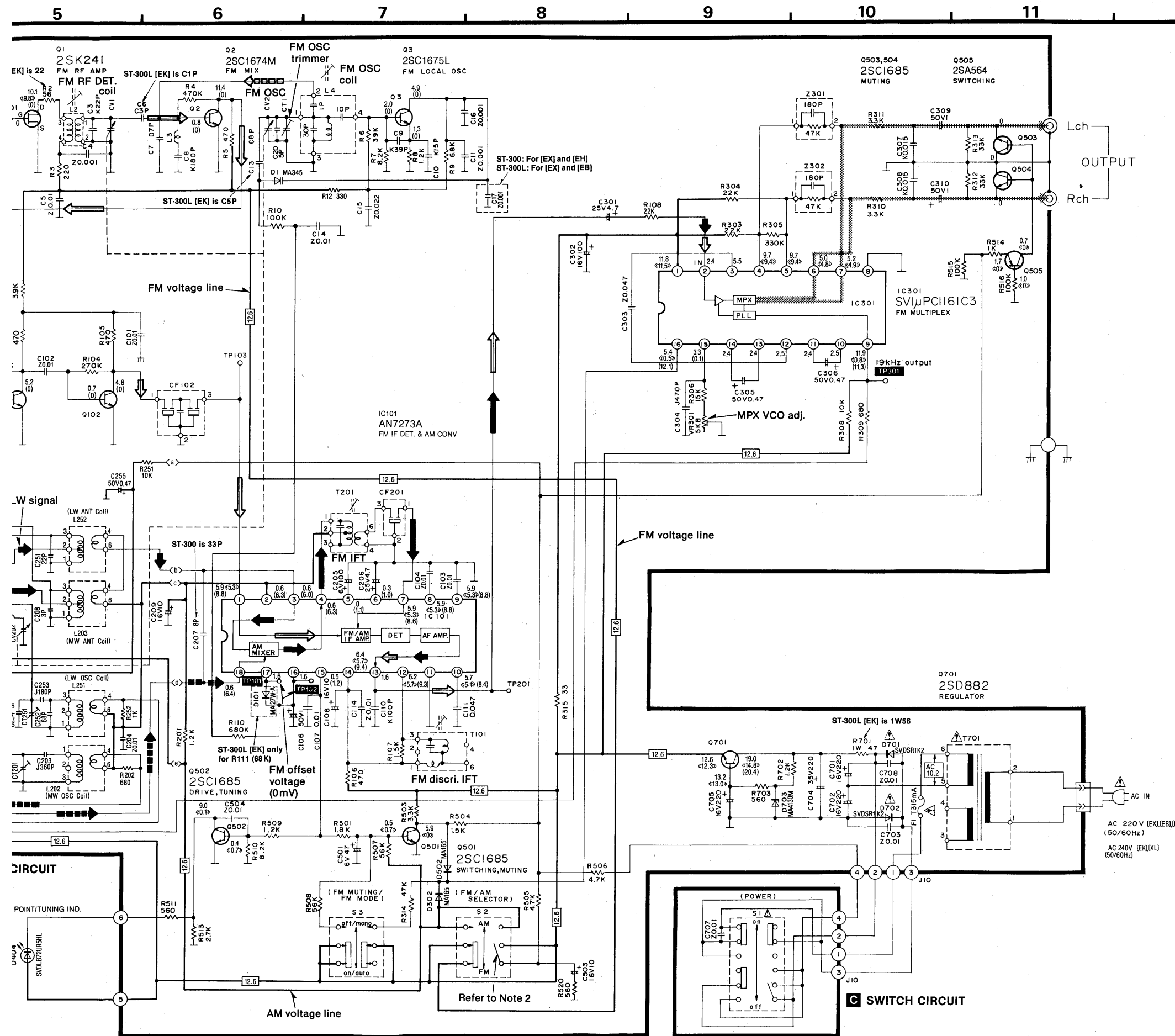
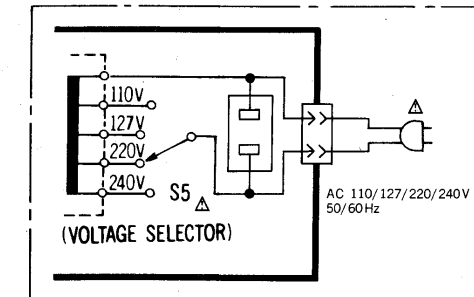

## REPLACEMENT PARTS LIST

- Notes:**
- Part numbers are indicated on most mechanical parts. Please use this part number for parts order.
  - Important safety notice: Components identified by  $\Delta$  mark have special characteristics important for safety. When replacing any of these components, use only manufacturer's specified parts.

- $\text{\textcircled{K}}$ -marked parts are used for black only, while  $\text{\textcircled{O}}$ -marked parts are for silver type only.
- Part other than  $\text{\textcircled{K}}$ - and  $\text{\textcircled{O}}$ -marked are use for both black and silver type.
- Bracketed indications in Ref. No. columns specify the area. Parts without these indications can be used for all areas.
- The parenthesized numbers in the column of description stand for the quantity per set.

### Change of Parts List (ST-300 from ST-300L)

Ref. No.	Change of Part No.		Part Name & Description	Pcs/Set	Remarks
	ST-300L [EK]	ST-300 [EX, EH, XA, XL]			
<b>COILS</b>					
L202	SLO2B15-M	SLO2B22-Z	AM OSC	(1)	
L203	SLA2B9-Z	SLA2B7	AM Antenna	(1)	
L205	ELEPK1R2MA	————	————	—	(Deletion)
L251	SLO1B7-M	————	————	—	(Deletion)
L252	SLA1B6-M	————	————	—	(Deletion)
<b>TRANSFORMERS</b>					
T701	SLT5K125	SLT5K123	[EX, EH] Power Transformer	(1)	$\Delta$
		SLT5K127	[XA] Power Transformer	(1)	$\Delta$
		SLT5K125	[XL] Power Transformer	(1)	$\Delta$
<b>VARIABLE CAPACITORS</b>					
CT1	ECRHA010A11	ECRHA010A41	FM OSC Trimmer	(1)	
CT201	ECRHA010A11	ECRHA007A41	AM OSC Trimmer	(1)	
CT202	ECRHA020D11	ECRHA007A41	AM ANT Trimmer	(1)	
CT251, 252	ECRHA020D11	————	————	—	(Deletion)
<b>FUSE</b>					
F1	XBA2C03TB0	XBA2C05TR0	250V, T315mA	(1)	$\Delta$
<b>SWITCHES</b>					
S4	SSH1190-1	————	————	—	(Deletion)
S5	————	SSR187-1	[XA] only Voltage Selector	(1)	(Addition) $\Delta$
<b>CABINET and CHASSIS PARTS</b>					
8	SJF8508N	SJF8508N	[EX, EH] Terminal Board	(1)	
		SJF8614N	[XA, XL] Terminal Board	(1)	
10	SUB161-1	————	Connection Rod	—	(Deletion)
12	————	SJS9232A	[XA] only AC Outlet Cover	(1)	(Addition)
13	————	SJS9232B	[XA] only AC Outlet	(1)	(Addition) $\Delta$
15	SGPT300L-SK	SGPT300-SE	[EX] Rear Panel Ass'y	(1)	
		SGPT300-SH	[EH] Rear Panel Ass'y	(1)	
		SGPT300-SX	[XA] Rear Panel Ass'y	(1)	
		SGPT300-SL	[XL] Rear Panel Ass'y	(1)	
23	$\text{\textcircled{O}}$ SGYT300L-SE	SGYT300-SE	Front Panel Ass'y	(1)	
23	$\text{\textcircled{K}}$ SGYT300L-KE	SGYT300-KE	Front Panel Ass'y	(1)	
23-1	SDU272Y	SDU272W	Dial Scale	(1)	
24	SHR301	SHR301	[XL] Clamper, Lead Wire	(1)	
		————	[other] ————	—	(Deletion)
<b>ACCESSORIES</b>					
A1	SFDAC05G02	SJA163	[XL] Cord, Power Source	(1)	$\Delta$
		SJA171	[other] Cord, Power Source	(1)	$\Delta$
A2	SQF12718	SQF12719	[XA] Instruction Book	(1)	
		SQF12718	[other] Instruction Book	(1)	
A3	SJP9009	SJP5213-1	[XA] only Cord, Pin	(1)	
		————	————	—	(Deletion)
A5	SSA270	SSA270	[EX, EH] FM Antenna cord	(1)	
		SSA269	[XA, XL] FM Antenna cord	(1)	

● ST-300L

Ref. No.	Part No.	Description
<b>INTEGRATED CIRCUITS</b>		
IC101	AN7273A	Integrated Circuit
IC301	SVIUC1161C3	Integrated Circuit
<b>TRANSISTORS</b>		
Q1	2SK241-GR	Transistor
Q2	2SC1674M	Transistor
Q3, 101, 102	2SC1675L	Transistor
Q501~504	2SC1685-QNC	Transistor
Q505	2SA722-S	Transistor
Q701	2SD882P-Q	Transistor
<b>DIODES</b>		
D1	MA345	Diode
D101	MA27W-A	Diode
D302, 502	MA165	Diode
D404	SVDLB72UR5HL	LED
D501	LN846RP	LED
D701, 702	SVDSR1K2	Rectifier
D703	MA4130M	Diode
<b>COILS</b>		
L1	SLA4N39	Antenna
L2	SLD4P71-P	Detector
L3, 204, 205	ELEPK1R2MA	Choke, 1.2μH
L4	SL04P121-P	OSC
L202	SL02B15-M	OSC
L203	SLA2B9-Z	Antenna
L251	SL01B7-M	Choke
L252	SLA1B6-K	Antenna
<b>TRANSFORMERS</b>		
T101	SLI4B519-Z	Transformer
T201	SLI2B105-M	Transformer
T701 [EK]	SLT5K125	Power Source
T701 [other]	SLT5K123	Power Source
<b>CERAMIC FILTERS</b>		
CF101, 102	SVFE107MS2-A	FM, 10.7 MHz (Red)
	SVFE107MS2-B	FM, 10.675 MHz (Blue)
	SVFE107MS2-C	FM, 10.725 MHz (Orange)
	SVFE107MS2-D	FM, 10.65 MHz (Black)
	SVFE107MS2-E	FM, 10.75 MHz (White)
CF201	SVFSFU450B3	AM, 450kHz
<b>VARIABLE RESISTOR</b>		
VR301	QVN83A00B472	FM MPX 4.7kΩ (B)
<b>VARIABLE CAPACITORS</b>		
CT1, 201	ECRHA010A11	Variable Capacitor
CT202, 251, 252	ECRHA020D11	Trimmer
CV201, 202	SVCCB42T916	Trimmer
<b>COMPONENT COMBINATIONS</b>		
Z301, 302	EXRP181K473C	180pF, 47kΩ
<b>FUSES</b>		
F1 [EK]	XBA2C03TB0	250V, T315mA
F1 [other]	XBA2C03TR0	250V, T315mA
<b>SWITCHES</b>		
S1	SSH1191-1	Power Source FM/AM Selector
S2, 3	SSH2092	
S4	SSH1190-1	MW/LW Selector

Ref. No.	Part No.	Description	
<b>CABINET and CHASSIS PARTS</b>			
1	○ SKCTZ250-SE	Cabinet	(1)
1	⊗ SKCTZ250-KE	Cabinet	(1)
2	SDD105-2	Drum	(1)
3	SUS295-1	Spring	(1)
4	SDZ051-2	Cord, Dial (1.4m/set)	(1)
5	SHG1595	Rubber	(1)
6	SJT347	Terminal, Fuse	(2)
7	SJS9230-1	Socket, AC Inlet	(1)
8	SJF8508N	Terminal Board	(1)
9	SUB187	Connection Rod	(2)
10	SUB161-1	Connection Rod	(1)
11	○ SBC315-4T	Button	(3)
11	⊗ SBC315-7	Button	(3)
14	SHE170	Holder	(3)
15 [EX]	SGPT300L-SE	Rear Panel Ass'y	(1)
15 [EK]	SGPT300L-SK	Rear Panel Ass'y	(1)
15 [EB]	SGPT300L-SB	Rear Panel Ass'y	(1)
( 15-1	( SKL296	Foot	(4)
16	○ SDE277	Knob, Tuning	(1)
16	⊗ SDE277-1	Knob, Tuning	(1)
17	SDT8276	Tuning Shaft	(1)
18	SUW2934	Bracket	(1)
19	SHP31-2	Spacer, Pointer	(1)
20	SDP5089	Pointer, Dial Ass'y	(1)
21	SDR31	Roller	(2)
22	○ SBC666	Button, Power Source	(1)
22	⊗ SBC666-3	Button, Power Source	(1)
23	○ SGYT300L-SE	Front Panel Ass'y	(1)
23	⊗ SGYT300L-KE	Front Panel Ass'y	(1)
( 23-1	( SDU272Y	Dial Scale	(1)
24	SHR301	Clamper, Lead Wire	(1)
[EK] only			
25	SJT783	Pin	(2)
26	SJS5215	Socket (2P)	(1)
27	SJT3213	Post (2P)	(1)
28	SHR5305	Cover	(1)
<b>SCREWS, WASHERS and NUTS</b>			
N1	XTBS3+8BFZ1	Tapping, ⌀3×8	(2)
N2	○ SNE2095-4	Cabinet	(2)
N2	⊗ SNE2095-5	Cabinet	(2)
N3	XYN26+C5FZ	⌀2.6×5	(1)
N4	XTW3+8T	Tapping, ⌀3×8	(1)
N5	XTBS3+12F1	Tapping, ⌀3×12	(3)
N6	XTBS3+8BFZ1	Tapping, ⌀3×8	(4)
N7	XTB3+8GFZ	Tapping, ⌀3×8	(3)
N8	XSN3+6S	Tapping, ⌀3×6	(1)
N9	XWH11H22	Washer	(1)
N10	XNS11	Nut, ⌀11	(1)
N11	XTB3+8G	Tapping, ⌀3×8	(2)
<b>ACCESSORIES</b>			
A1 [EK]△	SFDAC05G02	Cord, Power Source	(1)
A1 [other]	SJA171	Cord, Power Source	(1)
A2 [EK]	SQF12718	Instruction Book	(1)
A2 [other]	SQF12721	Instruction Book	(1)
A3	SJP9009	Attachment Plug	(1)
[EK] only			
A4	SJP2129-5	Pin Cord	(1)
A5	SSA270	Antenna, FM	(1)
A6	SSA902-5	Antenna, AM	(1)
A7	SMA231	Holder (Set used)	(1)
A8	SMA233-1	Holder (Ruck used)	(1)
A9	XTN3+10AFZ	Screw	(2)
<b>PACKING PARTS</b>			
P1 [EK] ○	SPG5650	Carton Box	(1)
P1 ○	SPG5649	Carton Box	(1)
[EX, EB]			
P1 [EK] ⊗	SPG5648	Carton Box	(1)
P1 ⊗	SPG5647	Carton Box	(1)
[EX, EB]			
P2	SPS4588	Pad, Left	(1)
P3	SPS4589	Pad, Left	(1)
P4	SPS4552	Pad, Upper	(1)
P5	○ XZB28X55C02	Polyethylene Bag	(1)
P5	⊗ SPP734	Polyethylene Bag	(1)

■ EXPLODED VIEW

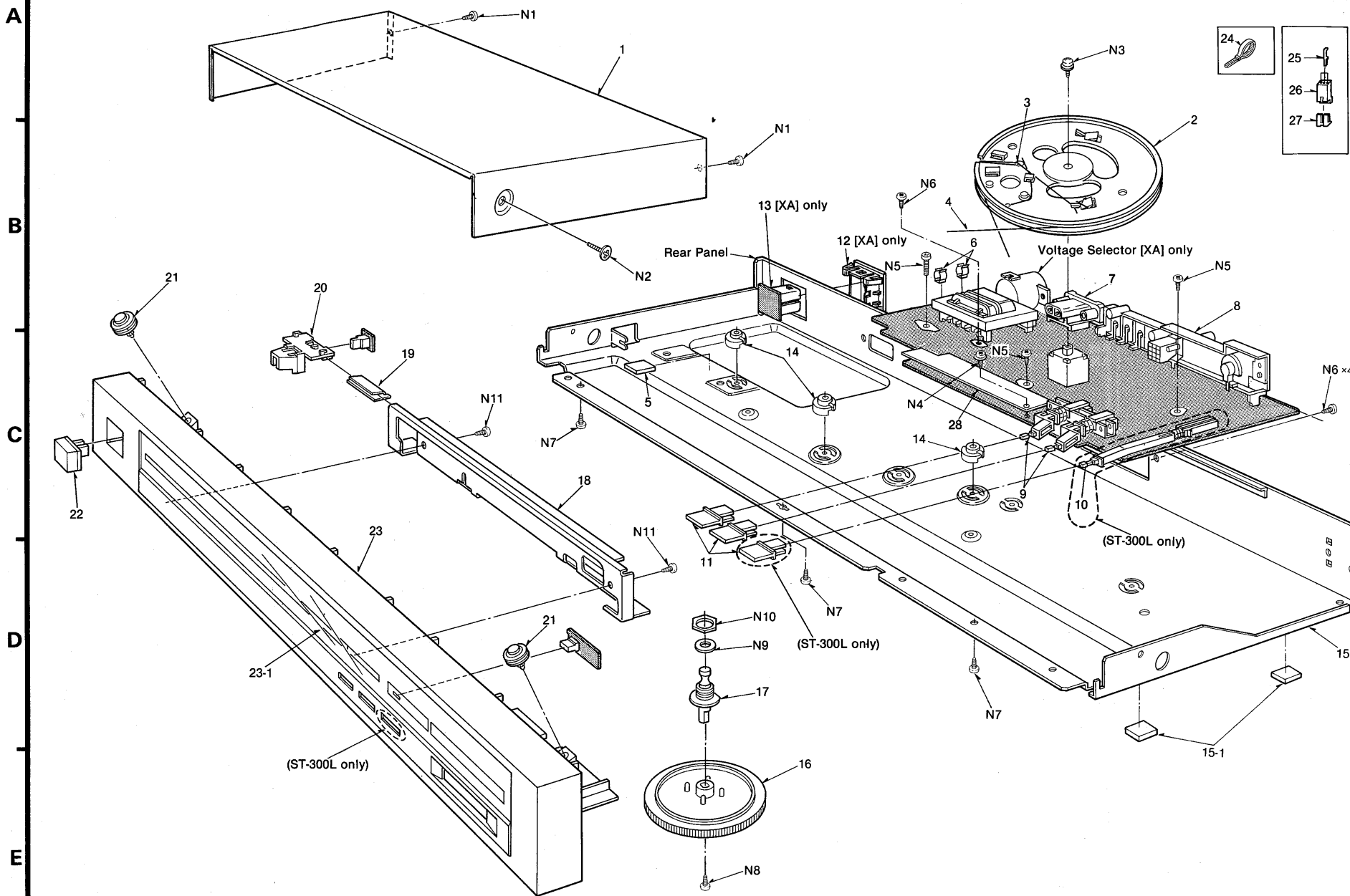

● Change of Parts List (ST-300 from ST-300L)

Ref. No.	Change of Part No.		Part Name & Description	Pcs/Set	Remarks
	ST-300L [EK]	ST-300 [EX, EH, XA, XL]			
<b>PACKING PARTS</b>					
P1	SPG5650	SPG5644	[EX, EH, XA] Carton Box (Silver Type)	(1)	
		SPG5645	[EX, EH, XA] Carton Box (Black Type)	(1)	
		SPG5646	[XL] only Carton Box	(1)	
P2	SPS4588	SPS4588-1	[XL] only Pad, Left	(1)	
		SPS4588	[other] Pad, Left	(1)	
P3	SPS4589	SPS4589-1	[XL] only Pad, Right	(1)	
		SPS4589-1	[other] Pad, Right	(1)	
P6	⊗	SGK1413	[XL] only Black Seal Label	(2)	(Addition)